

Zero 208

ZERO COLLECTION:
Zero 208, Zero 209,

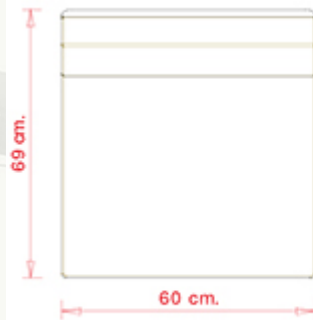
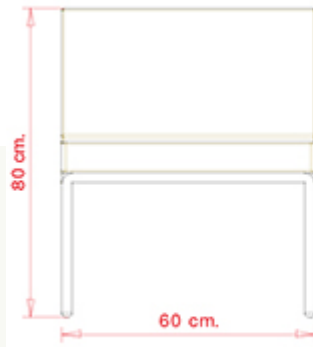

Modular sofa system with painted steel frame and cataphoresistreatment. Fabric for outdoors. Linear module.
*Stackable without cushion

STACKABLE

4*

WEIGHT

7,6 kg

PACK

0,50 m³

PIECES PER BOX

2

FINISHES SEATING

TE FABRICS

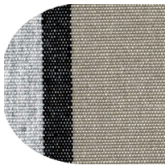

Solids&Stripes Sunbrella
+ 5 colours

FRAMES

AC STEEL



RAL 9005
VR Jet black
☀



RAL 9005
VR Matt Jet Black
☀



RAL 9016
VR Traffic white
☀



RAL 9010
VR Pure white
☀



PANTONE 402 C
VR Turtle-dove
☀



RAL 9006
VR White aluminium
☀



RAL 7016
VR Anthracite grey
☀



VR Pewter
☀



RAL 3003
VR Ruby red
☀



RAL 8017
VR Chocolate brown
☀

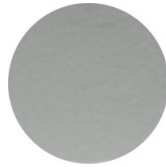

RAL 7037
VR Matt Dusty grey
☀



VR Rough metallic
bronze
☀

USES

coffee & restaurants, hotels, educational, entertainment,

Zero 209

ZERO COLLECTION:
Zero 208, Zero 209,

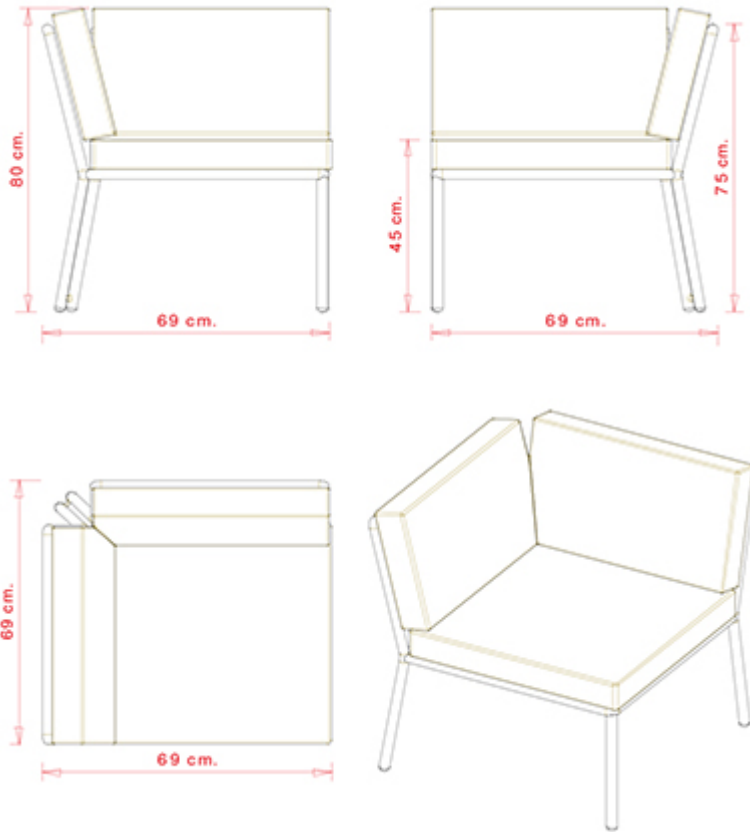

Modular sofa system with painted steel frame and cataphoresistreatment. Fabric for outdoors.
Corner module.
*Stackable without cushion

STACKABLE

2*

WEIGHT

10,2 kg

PACK

0,45 m³

PIECES PER BOX

2

FINISHES SEATING

TE FABRICS

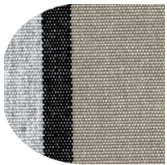

Solids&Stripes Sunbrella
+ 5 colours

FRAMES

AC STEEL



RAL 9005
VR Jet black
☀



RAL 9005
VR Matt Jet Black
☀



RAL 9016
VR Traffic white
☀



RAL 9010
VR Pure white
☀



PANTONE 402 C
VR Turtle-dove
☀



RAL 9006
VR White aluminium
☀



RAL 7016
VR Anthracite grey
☀



VR Pewter
☀



RAL 3003
VR Ruby red
☀



RAL 8017
VR Chocolate brown
☀

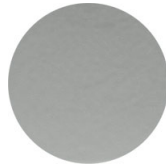

RAL 7037
VR Matt Dusty grey
☀



VR Rough metallic
bronze
☀

USES

coffee & restaurants, hotels, educational, entertainment,